

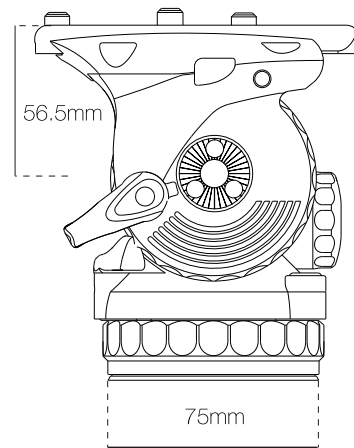

## GH06D 75mm Fluid Head



-  75mm
-  6.0kg  
13.2lbs
-  2.2kg  
4.9lbs
-  0-5



### FEATURES



3 plus 0 grades of pan & tilt drag



5 plus 0 steps of counterbalance











Quick install plate with only one press



Additional standard 1/4" & 3/8" screw hole

### SPECIFICATIONS

Model	GH06D
 Payload Range	1.0-6.0kg / 13.2lbs
 Counterbalance Range	0-5
 Grades Of Pan Drag	0-3
 Grades Of Tilt Drag	0-3
 Tilt Range	-60°/+90°
 Temperature Range	-40°C~+80°C
 Bowl Size	75mm
 Net Weight	2.2kg / 4.9lbs