



The magic life in the image world

E-IMAGE

HM-120 Hand-held Microphone

E-IMAGE HM-120 cardioid hand held microphone with durable all-metal construction and a balanced XLR output connector. It has a traditional long handle, can be used for live stage, vocal presentation, and studio applications.



47mm/1.9in

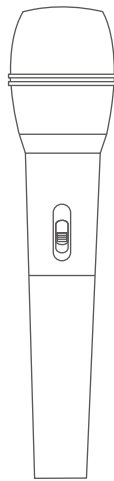

205mm/8.1in

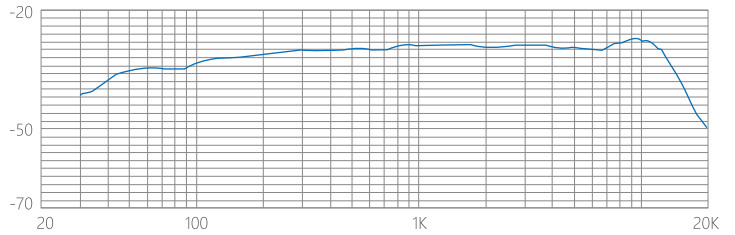
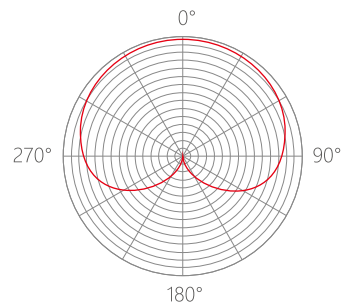

WHAT'S INCLUDED



①

②



| | |
|---------------------|-----|
| ① Microphone Clip | 1pc |
| ② HM-120 Microphone | 1pc |



SPECIFICATIONS

| | |
|-----------------------|------------------------------------|
| Element | Back Electret Condenser |
| Polar Pattern | Cardioid |
| Frequency Response | 40Hz-16KHz |
| Bass | Built-in |
| Sensitivity(48V/1.5V) | -36dB/-37dB±2dB(1dB=1V/Pa at 1KHz) |
| Output Impedance | 500Ω/600Ω±20% (at 1KHz) |
| Max.Input SPL | 130dB/115dB (T.H.D≤1% at 1KHz) |
| Signal to Noise Ratio | 70dB (1KHz at 1Pa) |
| Power Requirements | 48V DC/1.5V AA/UM3, 2mA |
| Net Weight | 390g |
| Size | Φ47 x 205mm |
| Output Interface | XLRM |

FEATURES





Cardioid

The cardioid polar pattern rejects off-axis sound, ideal for recording, concert.



The gold plated XLR link makes audio frequency current with ideal transmission..



With broad balanced range of frequency response.

40Hz-18kHz
Frequency response



Easy to use with ON/OFF switch.



Operates on 48V phantom power.



Rugged all-metal body.